



PATENT PENDING

Vasto-Clamp 6-Jaw Chuck

The versatile 6-jaw chuck with quick exchange system

Like the Makro-4Grip clamping system, the Vasto-Clamp 6-Jaw Chuck has been engineered for clamping round parts as well. While Makro-4Grip is primarily applied for clamping raw parts with the form-closure stamping technology, Vasto-Clamp uses a friction based principle for clamping round material securely. With its six top jaws Vasto-Clamp can be used for clamping raw parts with two different hardened gripping jaws or with soft jaws for components sensitive to deformation.

The manually actuated scroll chuck can be flexibly used as a 3- or 6-Jaw Chuck. The mounting and exchange of the jaws is realised without any tools by an innovative click mechanism, which provides a highly rigid and robust connection. The Vasto-Clamp chuck is available with integrated zero-point studs for our Quick-Point® zero-point clamping system, as well as an interface for the LANG RoboTrex automation.

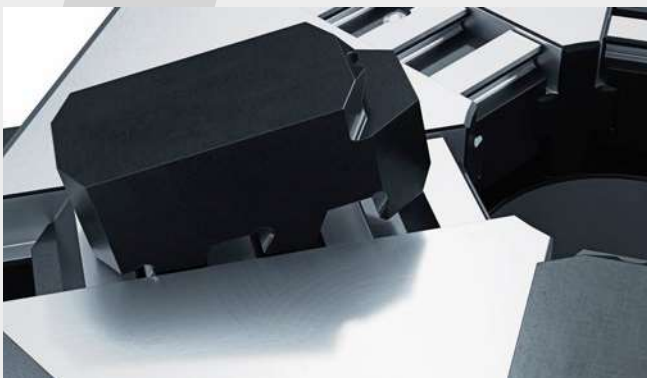

Without the use of any tools, the top jaws are locked into the base jaws (directional movement from the inside to the outside).



A spring-loaded ball bearing ensures a firm fit of the top jaw.

Vasto·Clamp Technology



Vasto·Clamp 6-jaw chuck with 6 soft top jaws



Vasto·Clamp 6-jaw chuck with 3 hardened gripping jaws

Technical features:

- Innovative click mechanism for a quick jaw exchange
- Different jaw types offer various application possibilities
- Gripper interface allows utilisation in the RoboTrex 96 automation system
- Integrated Quick·Point® zero-point interface
- Robust steel base for maximum durability
- Recess for an ergonomic handling
- Swarf and coolant drain

Applications

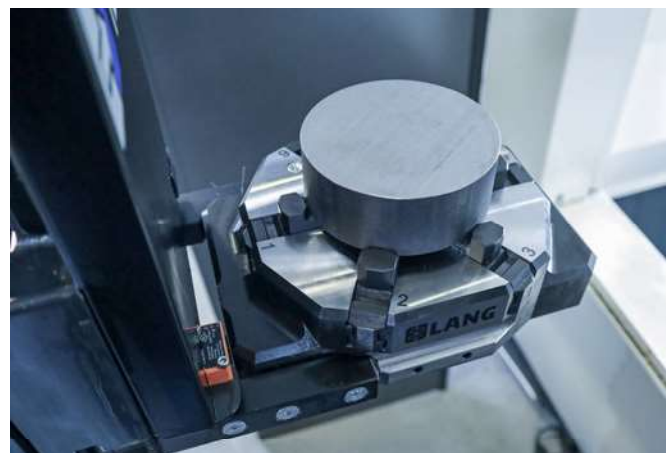
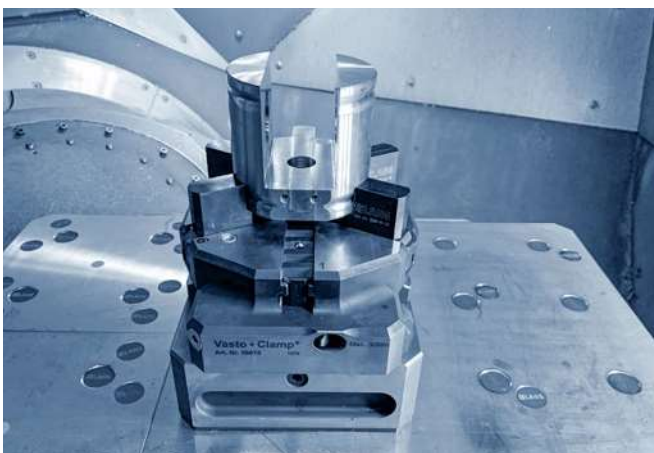

Source: CNC-Technik Ortlieb GmbH & Co.KG

Vasto-Clamp 6-Jaw Chuck



VASTO-CLAMP 6-JAW CHUCK

ITEM NO.	DIMENSIONS	CLAMPING RANGE
59616	210 × 155 × 57 mm	10 - 160 mm

Included in delivery: Hexagon socket square drive 1/4", size 8 mm

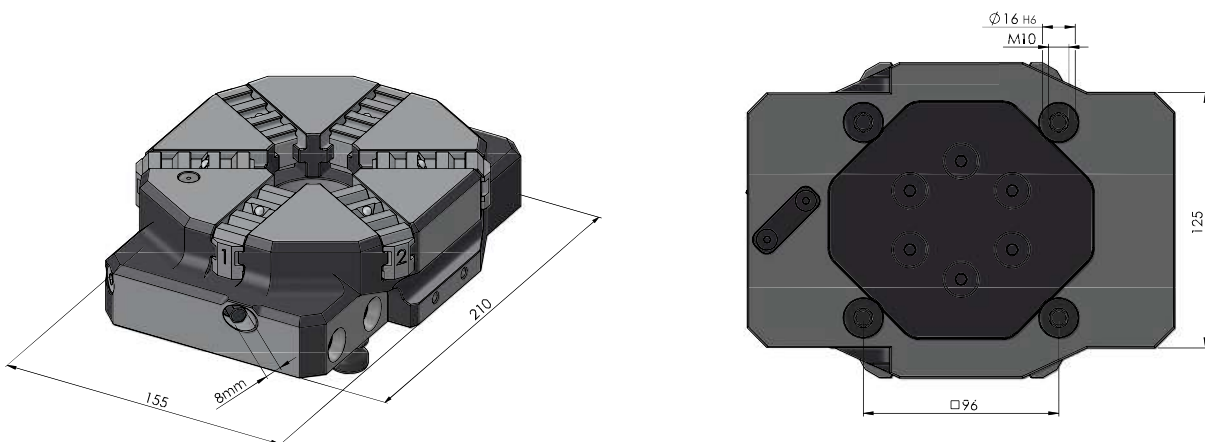

Vasto·Clamp Top Jaws

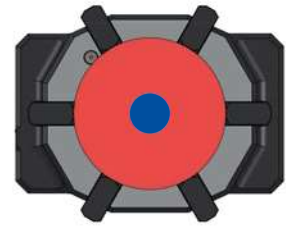
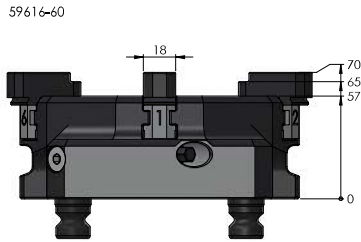

- min. Ø = 30 mm
- max. Ø = 120 mm

VASTO-CLAMP GRIPPING JAWS (HARDENED)

ITEM NO.	MATERIAL	CLAMPING RANGE	QUANTITY
59616-60	Steel (16 MnCr 5)	30 - 120 mm	6 pcs.

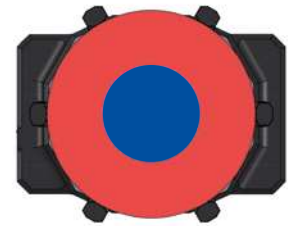
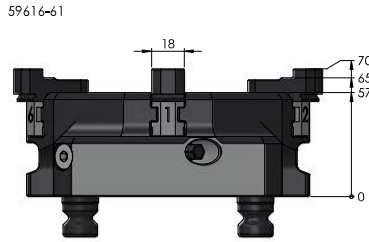

- min. Ø = 75 mm
- max. Ø = 160 mm

VASTO-CLAMP GRIPPING JAWS (HARDENED)

ITEM NO.	MATERIAL	CLAMPING RANGE	QUANTITY
59616-61	Steel (16 MnCr 5)	75 - 160 mm	6 pcs.

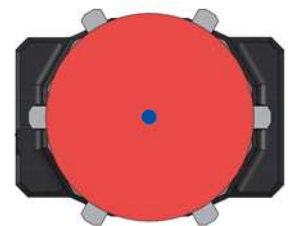
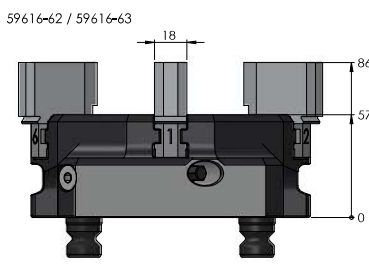

- min. Ø = 10 mm
- max. Ø = 160 mm

VASTO-CLAMP TOP JAWS (SOFT)

ITEM NO.	MATERIAL	CLAMPING RANGE	QUANTITY
59616-62	Steel (16 MnCr 5)	10 - 160 mm	6 pcs.
59616-63	Aluminium (F 50)	10 - 160 mm	6 pcs.